

4-562



■ **PRODUCT FEATURES**

- Style: Contemporary
- Collection: Diama
- Temperature Controlled Pressure Balance
- Lever Handle
-
-

■ **TECHNICAL DETAILS**

ADA Compliance: No
 Access Hole Diameter: 5"
 Handle Turn Angle: 115°
 Installation Type: Wall Mounted
 Primary Material: Brass
 Valve Material: Ceramic

■ **PRODUCT DIMENSIONS**

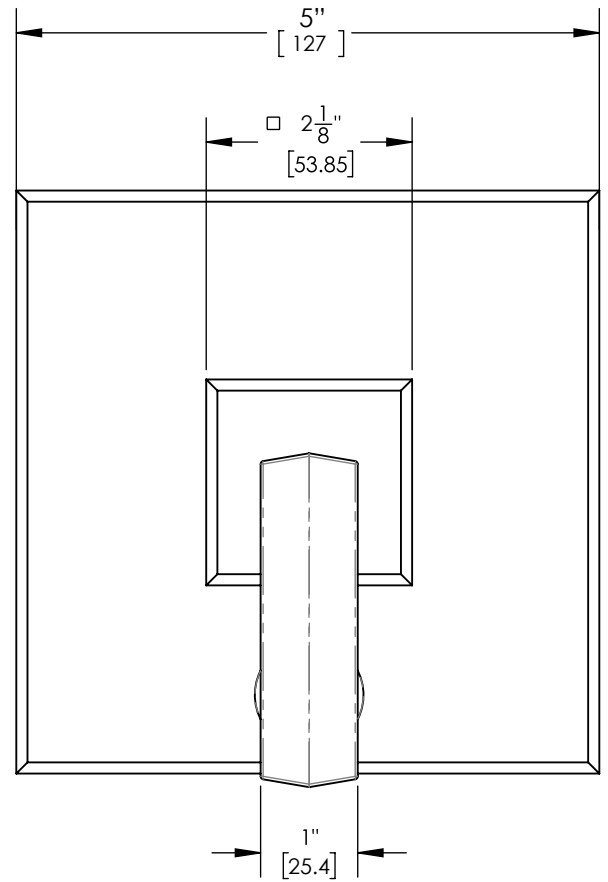
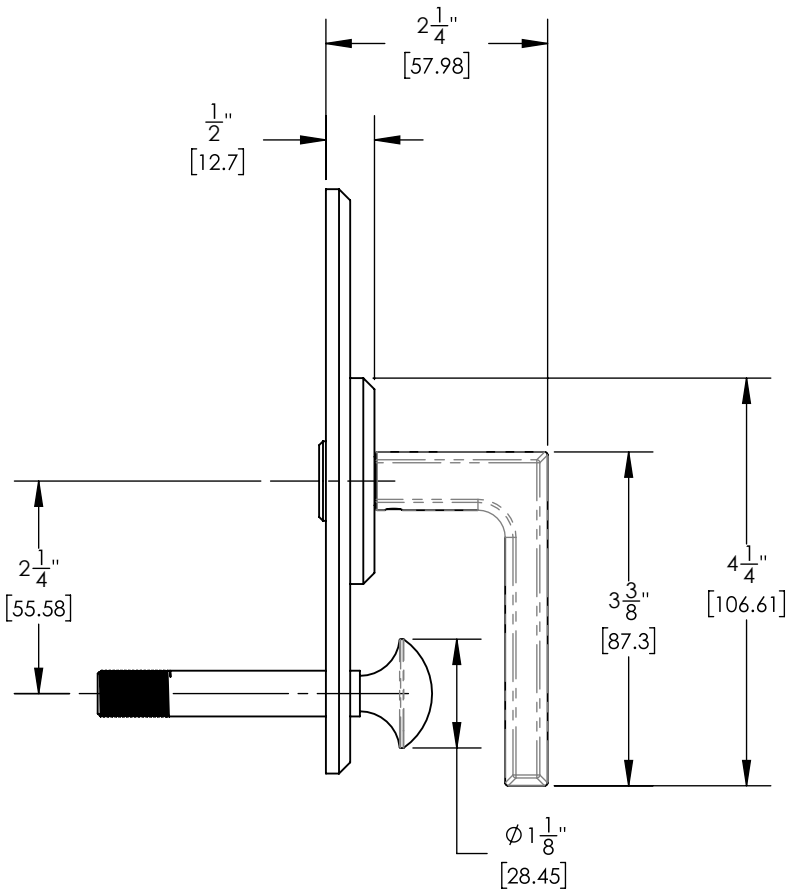

www.phylrich.com

1261 Logan Avenue, Costa Mesa, California 92626.
 Phone: 714.361.4800 Fax: 714.617.3120



CODES & STANDARDS

ASME A112.181/ CSA B1251, ASME 112.18.2/ CSA B125.2, ANSI NSF, CEC

WARRANTY

Mechanical Warranty: 10 Years from date of purchase.
 Finish Warranty: See catalog for further information.

Rev-