

3-801



■ **PRODUCT FEATURES**

■ **TECHNICAL DETAILS**

Hand Shower Flow Rate: 1.8 gpm  
Primary Material: Plastic

■ **PRODUCT DIMENSIONS**

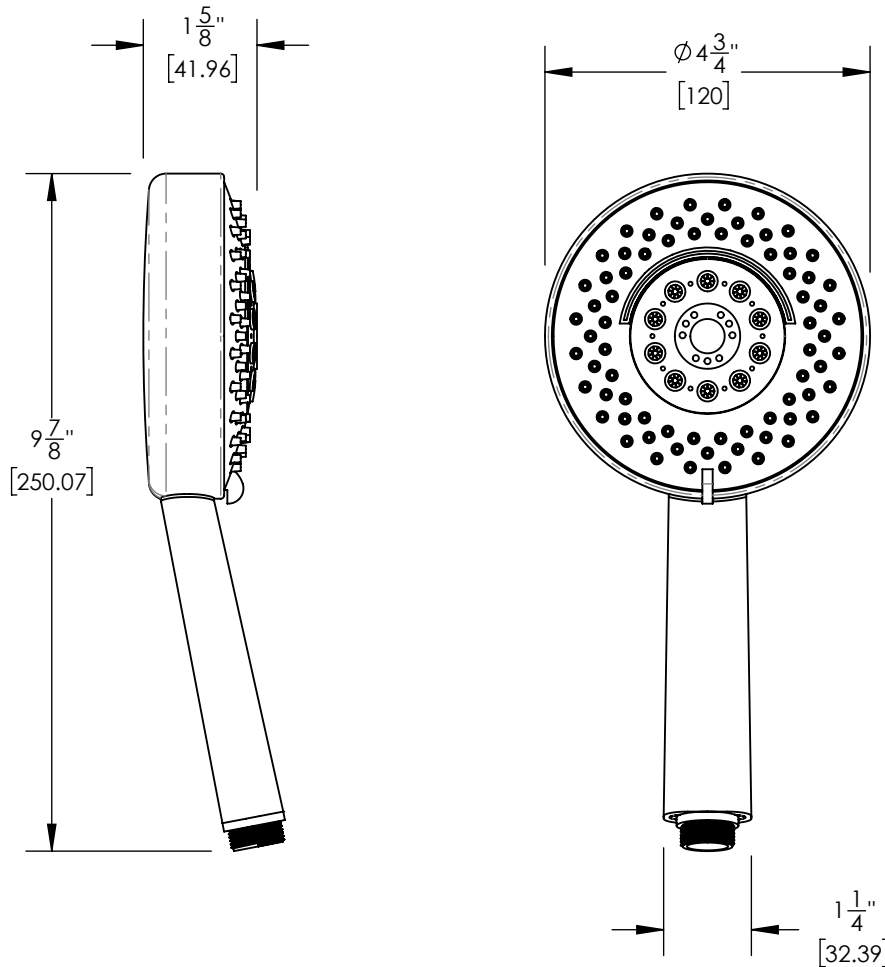

[www.phylrich.com](http://www.phylrich.com)

1261 Logan Avenue, Costa Mesa, California 92626.  
Phone: 714.361.4800 Fax: 714.617.3120



**CODES & STANDARDS**

ASME A112.181/ CSA B1251, ASME 112.18.2/ CSA B125.2, ANSI NSF, CEC

**WARRANTY**

Mechanical Warranty: 10 Years from date of purchase.  
Finish Warranty: See catalog for further information.

Rev-