

- NOTE(S):
 1. PART NUMBER, "/00" DENOTES PART SHALL HAVE FINISH.
 2. APPLY NSF COMPLIANT GREASE TO ANY O-RING, SEALING JOINTS, AND/OR PIVOTAL POINTS.
 3. APPLY NSF COMPLIANT LOCTITE TO THREADED AREA.
 4. APPLY NSF COMPLIANT REMOVABLE (BLUE) LOCTITE TO THREADED AREA.
 5. SILVER SOLDER JOINTS SHALL BE FULLY WETTED VIA CAPILLARY ACTION AND COMPLETELY NON-POROUS.

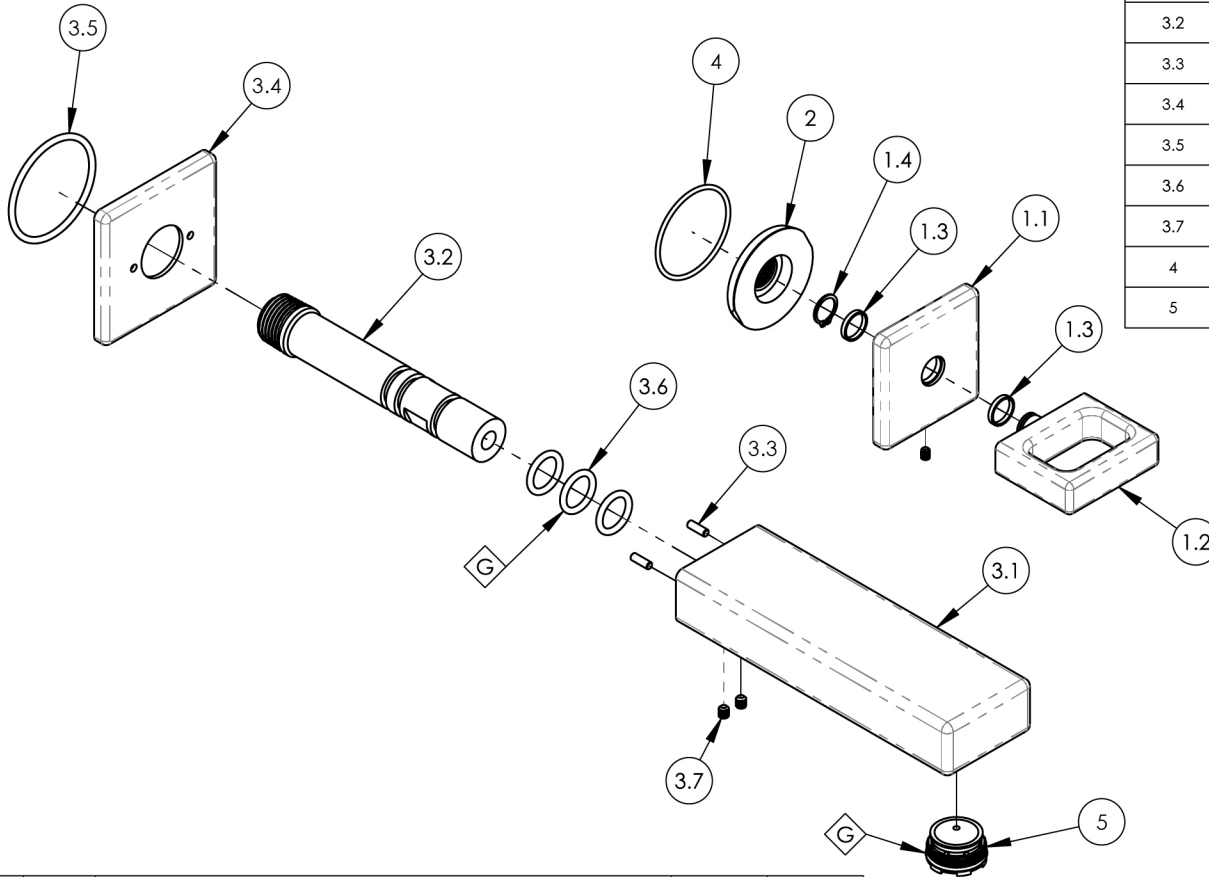

ITEM NO.	PART NUMBER	DESCRIPTION	QTY.
1	3-103/00	ASSY, HANDLE WINDOW MIX	1
1.1	10932/00	THERM, SHOWER TRIM, THREE HANDLE, CROSS, CROI	1
1.2	10925/00	HANDLE, RING/WINDOW, MIX SERIES	1
1.3	92176	WEAR WASHER	2
1.4	92177	RETAINING RING, 7/16" SHAFT	1
1.5	92005	SET SCREW, CUP PT 6-32 UNC THREAD 3/16"L	1
2	11003	SLEEVE MOUNT, WALL MT WIDESPREAD	1
3	3-999/00	ASSY, WALL SPOUT, 6", MIX	1
3.1	12704/00	WALL SPOUT, 6", DIAMA	1
3.2	10013	INJECTOR SHANK, 1/2"NPT MALE TO M16.5 CACHE W/ O-SEAL	1
3.3	92158	DOWEL PIN, 1/8" X 3/8"L	2
3.4	10934/00	ESCUTCHEON, SPOUT RT MIX SERIES	1
3.5	90131	O-RING, 1-11/16ID X 3/32THK, AS-568-131	1
3.6	90113	O-RING, 9/16"ID X 3/4"OD X 3/32"THK, AS-568-113	3
3.7	92008	SET SCREW, CUP POINT 8-32, 3/16" L.	2
4	90029	O-RING, 1-5/8"ID X 1-3/4"OD X 1/16"THK, AS-568-029	1
5	11427	AERATOR, CACHE REG, PINK 1.2 GPM, M24X1.0, NEOPERL # 40.2360.010	1



ZONE	REV.	DESCRIPTION	DATE	APPROVED
------	------	-------------	------	----------

REVISIONS

1261 LOGAN AVENUE
 COSTA MESA, CALIFORNIA 92626
 PHONE: 714.361.4800
 FAX: 714.617.3120

PHYLIRICH[®]
 Defining Luxury Since 1959

PROPRIETARY AND CONFIDENTIAL
 THE INFORMATION CONTAINED IN THIS DRAWING IS THE SOLE PROPERTY OF PHYLIRICH. ANY REPRODUCTION IN PART OR AS A WHOLE WITHOUT THE WRITTEN PERMISSION OF PHYLIRICH IS PROHIBITED.
 DO NOT SCALE DRAWING

ASSY, WALL LAV, SINGLE RING HANDLE, 6" L, MIX

SIZE A	ASM/PRT NO. 290-19-6/00	REV -
SCALE: 1:8	WEIGHT: lbs.	SHEET 1 OF 2