

220-50



■ **PRODUCT FEATURES**

- Style: Transitional
- Collection: Works
- Temperature Controlled By Handles
- Cross Handles
- High Square Spout

■ **TECHNICAL DETAILS**

ADA Compliance: Yes  
 Deck Thickness Maximum: 2"  
 Deck Thickness Minimum: 1/8"  
 Fitting Hole Diameter: 1 1/8"  
 Number of Holes: Three Hole  
 Number of Handles: Two  
 Handle Spread Maximum: 12"  
 Handle Spread Minimum: 8"  
 Handle Turn Angle: Quarter Turn  
 Spout Reach: 9"  
 Spout Height: 7 7/8"  
 Inlet Connection Type: Male 3/4" NPT  
 Installation Type: Deck Mounted  
 Primary Material: Brass  
 Valve Material: Ceramic  
 Shower Flow Restriction: Full Flow  
 Hand Shower Flow Restriction: 1.8 GPM  
 Water Pressure Maximum: 85 PSI  
 Water Pressure Minimum: 20 PSI  
 Water Pressure Recommended: 60 PSI

■ **PRODUCT DIMENSIONS**

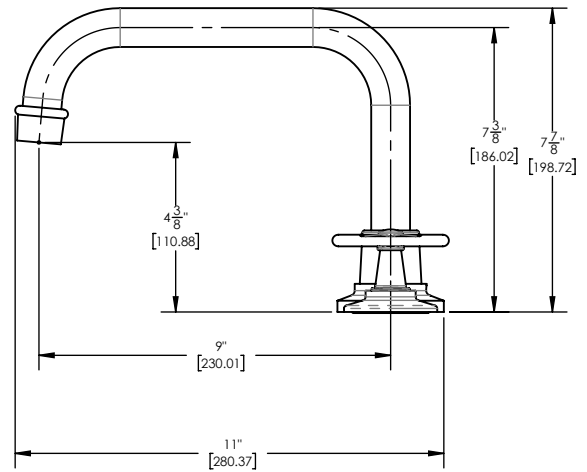
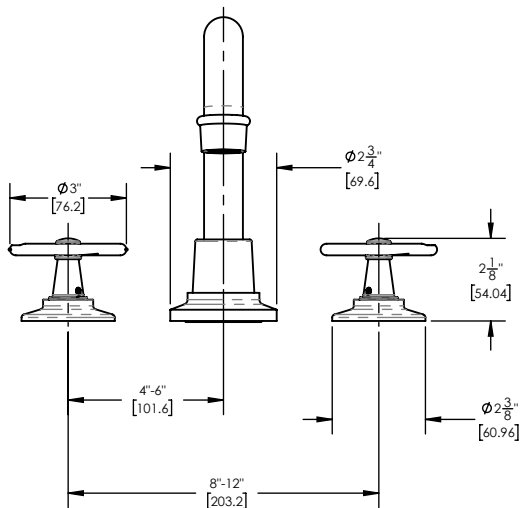
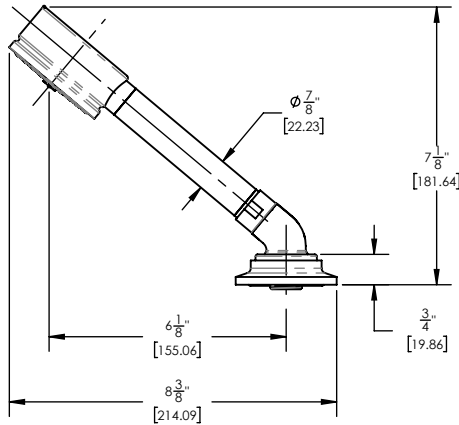

www.phylrich.com

1261 Logan Avenue, Costa Mesa, California 92626.  
 Phone: 714.361.4800 Fax: 714.617.3120



**CODES & STANDARDS**

ASME A112.181/ CSA B1251, ASME 112.18.2/ CSA B125.2, ANSI NSF, CEC

**WARRANTY**

Mechanical Warranty: 10 Years from date of purchase.  
 Finish Warranty: See catalog for further information.