

120-27-12



■ **PRODUCT FEATURES**

- Style: Transitional
- Collection: Transition
- Temperature Controlled By Pressure Balance
- Lever Handles
- 
- 

■ **TECHNICAL DETAILS**

Access Hole Diameter: 5"  
 Handle Turn Angle: 115°  
 Spout Reach: 12"  
 Connection Type: Female 1/2" NPT Connection  
 Installation Type: Wall Mounted  
 Primary Material: Brass  
 Valve Material: Ceramic  
 Shower Flow Restriction: 1.8 gpm  
 Spout Flow Restriction: Full Flow  
 Water Pressure Maximum: 85 PSI  
 Water Pressure Minimum: 20 PSI  
 Water Pressure Recommended: 60 PSI

■ **PRODUCT DIMENSIONS**

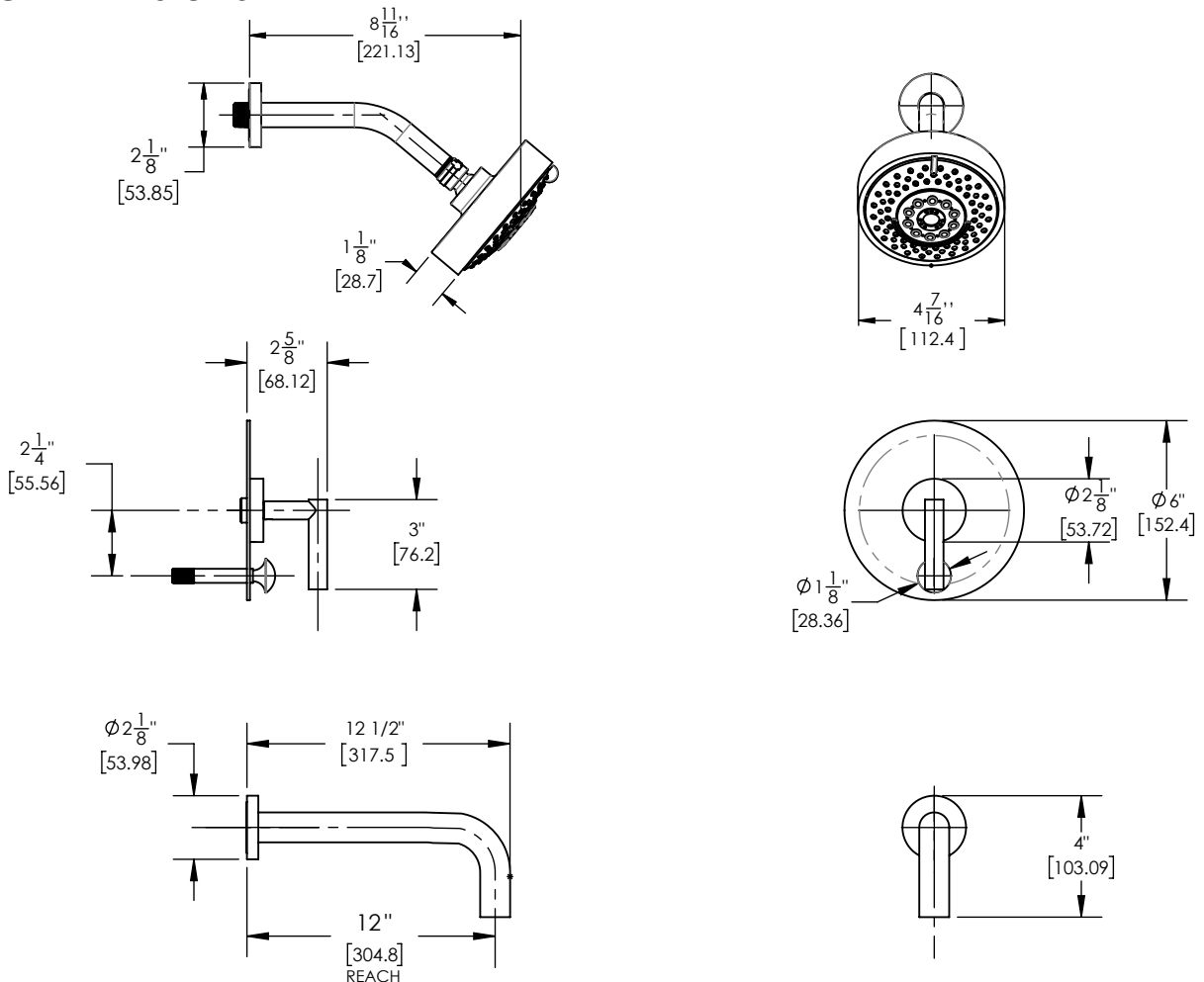

www.phylrich.com

1261 Logan Avenue, Costa Mesa, California 92626.  
 Phone: 714.361.4800 Fax: 714.617.3120



**CODES & STANDARDS**

ASME A112.181/ CSA B1251, ASME 112.18.2/ CSA B125.2, ANSI NSF, CEC

**WARRANTY**

Mechanical Warranty: 10 Years from date of purchase.  
 Finish Warranty: See catalog for further information.

Rev-