

120-26-10



■ **PRODUCT FEATURES**

- Style: Transitional
- Collection: Transition
- Temperature Controlled By Pressure Balance
- Cross Handles
-
-

■ **TECHNICAL DETAILS**

Access Hole Diameter: 5"
 Handle Turn Angle: 115°
 Spout Reach: 10"
 Connection Type: Female 1/2" NPT Connection
 Installation Type: Wall Mounted
 Primary Material: Brass
 Valve Material: Ceramic
 Shower Flow Restriction: 1.8 gpm
 Spout Flow Restriction: Full Flow
 Water Pressure Maximum: 85 PSI
 Water Pressure Minimum: 20 PSI
 Water Pressure Recommended: 60 PSI

■ **PRODUCT DIMENSIONS**

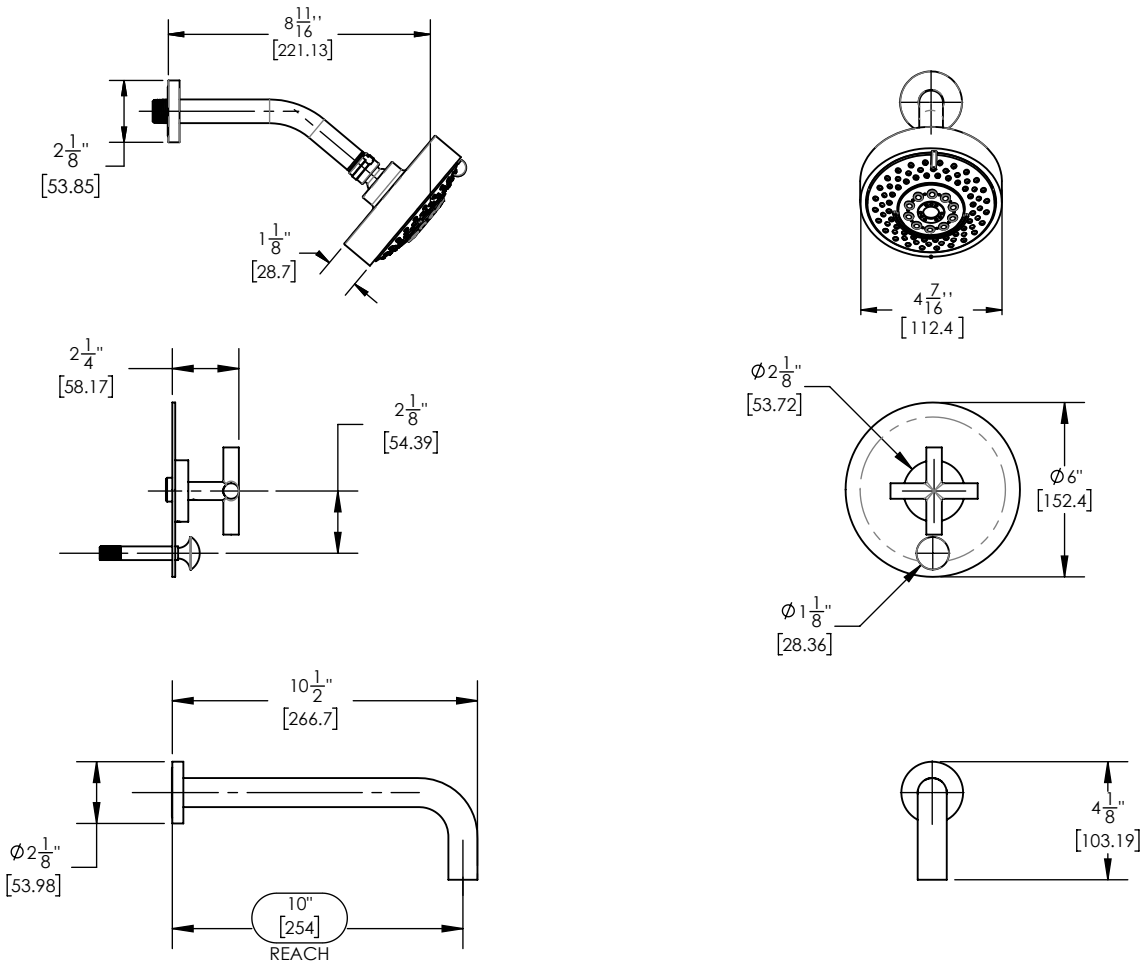

www.phylrich.com

1261 Logan Avenue, Costa Mesa, California 92626.
 Phone: 714.361.4800 Fax: 714.617.3120



CODES & STANDARDS

ASME A112.181/ CSA B1251, ASME 112.18.2/ CSA B125.2, ANSI NSF, CEC

WARRANTY

Mechanical Warranty: 10 Years from date of purchase.
 Finish Warranty: See catalog for further information.

Rev-